

USER MANUAL



Thank you for choosing Better Bathrooms.
Please read this manual before installing your product
and keep for future reference.

better 
bathrooms

Park Royal Paintable Freestanding Bath Double Ended 1515X740X640

BeBa_27688



- **Two-person assembly**
- **Tools required**
- **We always recommend using professional tradespeople to install your product**

V1_23.09.21

Congratulations on your purchase

And welcome to our growing gang of savvy shoppers

We're on a mission to bring you extraordinary bathroom products, for less. From modern to traditional style ceramics, plus the gorgeous fixtures, fittings and furniture to match. So, you can fall in love with your space every single day.

As one of the UK's largest independent bathroom stores, we've received countless awards; including the National Business Awards UK, the Digital Entrepreneur Awards and being placed on The Sunday Times Fast Track 100.

We hope your new product goes above and beyond your expectations. However, should any problems occur, please:

- log in to your account and contact our customer services team via your self-serve portal – betterbathrooms.com/CustomerAccount/Login
- contact us via betterbathrooms.com/content/contact-us

Important information

- Please read these instructions thoroughly and retain for future reference
- Always check for pipes and cables before drilling
- Freestanding bath is not designed to take weight on the rim, Do not sit or stand on the bath rim.
- Bath feet and waste are supplied separately.
- Painting must be carried out in a well ventilated space.
- The area being used for painting must be protected against splashes and spills, we also recommended mask and goggles are used during sanding and painting.

Selecting Your Paint

The paint to be used on your bath must be tile paint or paint which is waterproof or water resistant, normal household paint cannot be used.

Receive Your Bath

Unpack and check for damage.

After receiving your bath, please unpack and remove all packaging, checking for damage, damage reported after painting will not be covered.



Repack the bath if it is not being immediately installed.

Protect your bath.

Before commencing painting and installation, ensure the bath is completely protected, leave covering in place until the bathroom is complete. Scratches and damage incurred during installation are not covered by the warranty.



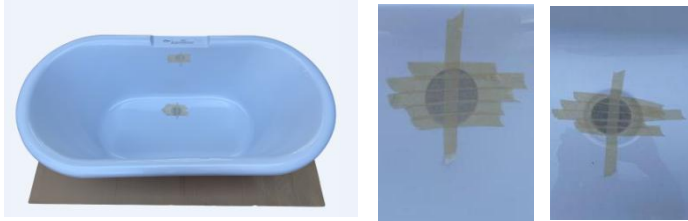



DIY Painting Operation Instructions

The paint to be used on the bath **must** be tile paint or paint which is waterproof or water resistant, normal household paint cannot be used.

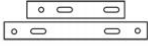
Image References	Steps
	<p>Step 1: Unpack the bath from its packaging, check for damage and place onto a protected surface to prevent any damage occurring, damage reported after painting will not be covered.</p> <p>Please note, located on the underside of the bath is a plastic sheet and roll of masking tape to be used during painting.</p>
	<p>Step 2: Cover the waste and overflow, as shown using the masking tape, to prevent any paint running through to the inside surface of the bath.</p>
	<p>Step 3: Attach the plastic sheet to the bath as show using the masking tape, covering the surface to the outer edge of the roll top to prevent any paint splashes on the inside of the bath.</p> <p>If at any point paint splashes do occur on the inside, they must be wiped off immediately.</p>
	<p>Step 4: Place the bath onto a protected surface face down.</p> <p>Remove any labelling and remove the nuts and washers from the feet bolts and keep in a safe place.</p> <p>Tape the threaded bolts using the masking tape.</p>
<p>Step 5: The bath received is pre-sanded for painting. But please check for any fines scratches, if any are present they can be lightly sanded out, using a fine grade sand paper. After sanding, brush clean and wipe the outer surface with a damp cloth and leave to fully dry, do not apply any paint to the surface if it is not clean or it is wet.</p>	
<p>Step 6: Apply the first coat of paint, we recommend a small roller for best and even application. Leave to dry for the period stated on the paint instructions. Apply additional coats as required, leaving to fully dry between applications.</p>	
<p>Step 7: Only once the paint is completely dry, you can now fit the bath feet and waste. You will need to remove the tape from the threaded bolts, the plastic sheet and the tape from the waste and overflow. Follow the "Feet Installation Instruction".</p>	

Feet Installation

Parts

No.	Part	Qty			Pic
		Option A	Option B	Option C	
A	Bar	4	3	2	
B	Screw	4	4	4	
C	Nut	12	10	8	
D	Washer	12	10	8	
E	Fastener washer	4	4	4	
F	Adjustable feet	4	4	4	

Tools required



Adjustable Wrench

Installation

Step 1

- ① Ensure the bath is on a soft surface to protect against scratches.
- ② Place the bars onto the bath, along with the washers and nuts as shown below, do not tighten at this stage to allow for adjustment, taking care not to damage the newly painted surface.

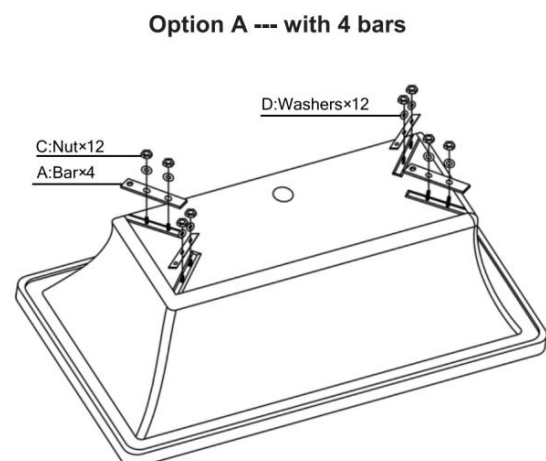
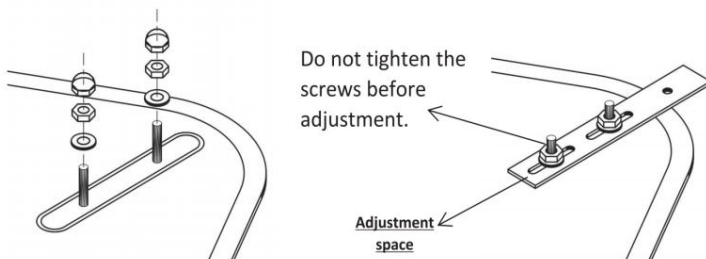

Option B --- with 3 bars

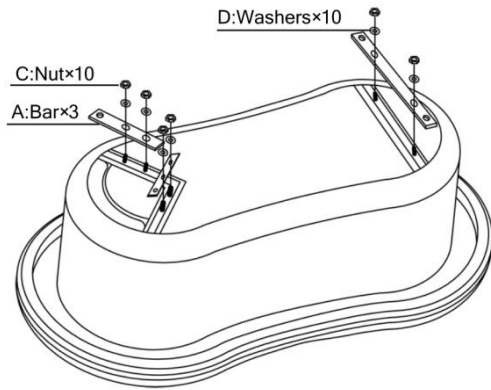

Option C --- with 2 bars

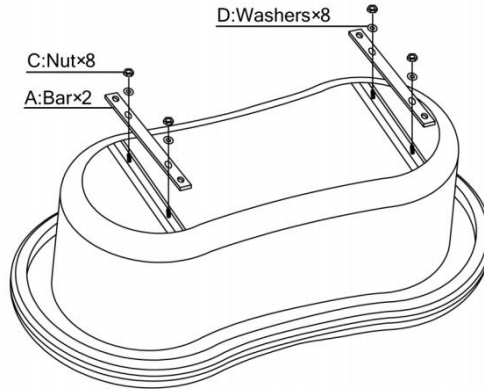

Step 2

- ① Position the feet onto the bars and secure using the nuts and bolts provided.
- ② Adjust the position of the feet to align with the bath.
- ③ Tighten all of the nuts so that the feet are secured to the bar and the bars are secured to the bath.

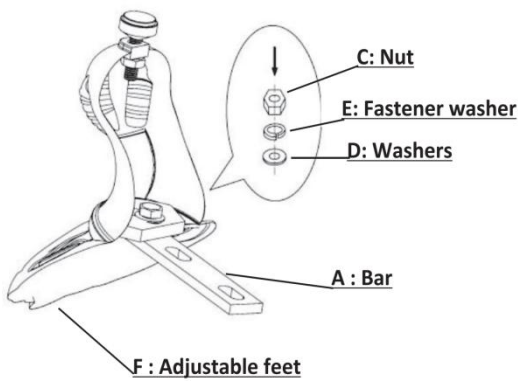

Option A --- with 4 bars

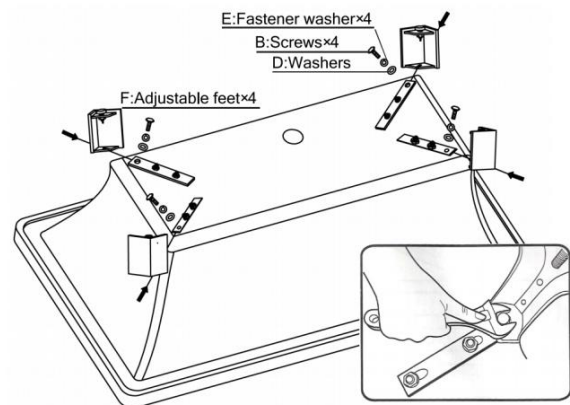

Option B --- with 3 bars

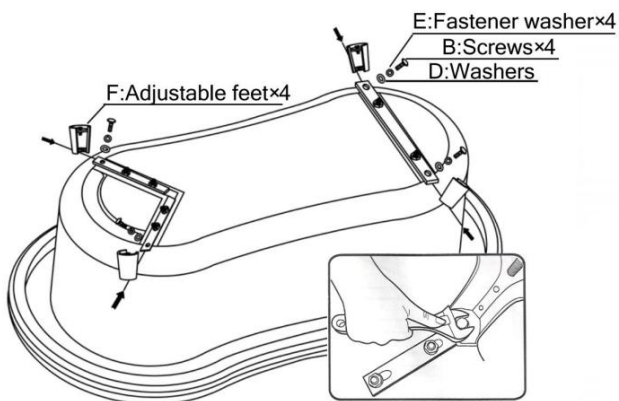

Option C --- with 2 bars

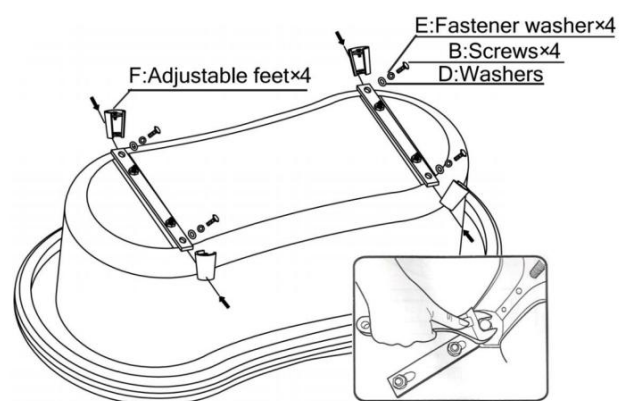

Troubleshooting

- Movement in the feet after assembly

Please check the feet are assembled properly, make sure fastener washers and washers are placed correctly.

Maintenance & Cleaning

- Marks on the painted surface should be wiped clean with a soft damp cloth and dried.
- Marks on the inside of the bath, should be cleaned using a soft damp cloth, for more stubborn marks, toothpaste can be applied and then rinsed thoroughly.
- No harsh cleaning chemicals or abrasive materials can be used on any surface.
- If using coloured oils/creams, carry out a test on small area prior to use to ensure that these will not cause staining.
- Never pour coloured oils/creams directly into an empty bath, always apply them into the bath water.

! Warning

Pay attention to below points if the bath is designed with tap deck.

- ① The tap holes are not pre-drilled on the deck, drill holes according to your need.
- ② Check and silicone the tap holes to make sure they are solid after drilling.
- ③ Check and make sure that there is no water leakage at the faucet.

Illustrations below are for reference only

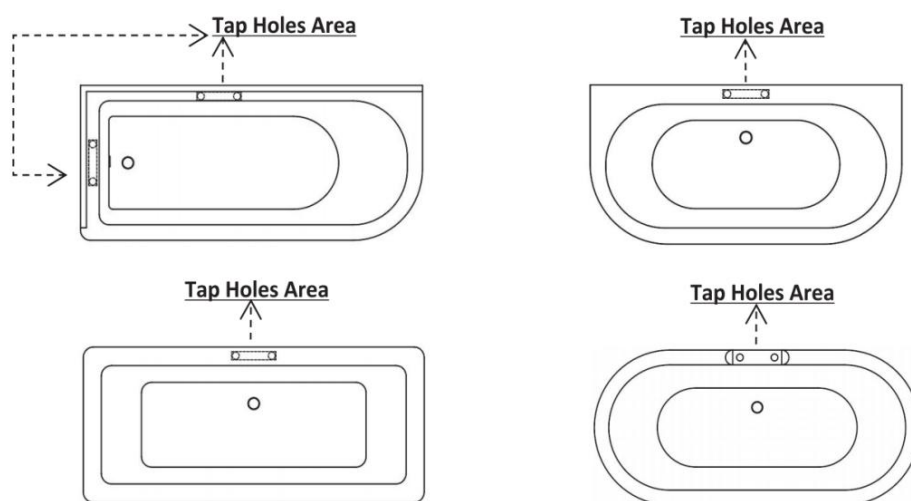

For more information

- visit betterbathrooms.com
- email customerservices@buyitdirect.co.uk
- call 0330 390 3062
- write to Trident Business Park, Neptune Way, Huddersfield, HD2 1UA

**better
bathrooms**

Part of the BuyItDirect Group